

Robust Transmission of H.264/AVC Video using 64-QAM and unequal error protection

Ahmed B. Abdurrahman¹, Michael E. Woodward¹ and Vasileios Theodorakopoulos²

¹School of Informatics, Department of Computing, University of Bradford, U.K.
{A.Abdurrahman, M. E. Woodward}@bradford.ac.uk,
vtheodor@hontmail.com

Abstract. This paper presents a robust transmission of H264/AVC coded video using hierarchical quadrature amplitude modulation (HQAM), which takes into consideration the non-uniformly distributed importance of frames in a group of pictures (GOP) intracoded (I-frames) and predictive coded frames (P-frames) as well as the sensitivity of the coded bitstream against transmission errors. Unequal error protection is based on uniform and non-uniform HQAM constellations in conjunction with different scenarios of splitting the bits of transmitted symbol for protection of the more important information of the video content. The performance of the transmission system is evaluated under additive Gaussian noise (AWGN) conditions. The simulation results demonstrate that the proposed strategy produces a better quality of the reconstructed video data compared with a system that offers uniform protection.

Keywords: H.264/AV, video over wireless networks, hierarchical QAM, unequal error protection.

1 Introduction

With the development of multimedia communication services, robust video transmission in a wireless environment poses many challenges. The lossy wireless channel causes high transmission errors of the compressed video data and resulting in the deterioration of the video reconstruction quality. As the video compression standards have been developed for relatively error free environments they cannot be directly transferred to a hostile mobile environment due to the extensive employment of variable length coding techniques which are error sensitive since a single transmission error may result in an undecodable string of bits. Therefore an essential issue is how to protect highly error sensitive video information in hostile mobile environments [2], [4]. Several error resilient video coding techniques have been proposed, as seen in [1], in order to minimize the effects of the transmission errors on the reconstructed video image quality. Unequal error protection (UEP) of the coded video bit-stream is one of the most successful techniques. The main idea of (UEP) is based on the fact that the bits in a compressed video stream are not equally important. For example the motion vectors and picture header are much more important than the

texture video data [4]. The reconstructed video quality will be severely degraded if the visually important video data is affected by errors; these important bits should be given a higher protection order than the rest of the video bit-stream. Hierarchical modulation is another way of UEP, in which the high priority (HP) data bits of the coded video are mapped to the most significant bits (MSB) of the modulation constellation points while the low priority (LP) data bits of the coded video are mapped to the least significant bits (LSB) of the modulation constellation points [1], [3]. The overall video quality will be improved compared with non-hierarchical modulation at low channel signal to noise ratio (SNR) conditions since the highly sensitive HP data bits are mapped to the MSBs of the hierarchical QAM (HQAM) with low BER. The UEP employing the hierarchical quadrature amplitude modulation (HQAM) was proposed in [7] where NAL-A units constitute the HP bits while NAL-B and NAL-C units constitute the LP bits.

This paper presents the UEP of H.264/AVC coded video using hierarchical 64-QAM, which takes into consideration the non-uniformly distributed importance of I-frame and P-frame. The protection provided to the compressed video bits-stream is non-uniformly distributed between the video frames to minimize the picture quality degradation due to the transmission errors. The paper is organised as follows. An overview of 64-HQAM is given in section 2. Section 3 shows the proposed UEP and results are presented in section 4. Conclusions and future work are given in section 5.

2 Hierarchical 64-QAM

To comply with the high bit rate requirement for video transmission, it is desirable to choose a bandwidth efficient modulation technique. For this reason a 64-QAM is selected mainly due to its superb spectral efficiency which can satisfy the high data rate required, by assigning more bits to each transmitted symbol. However, modulation schemes that allow a larger number of bits per symbol, have symbols closer to each other in the constellation diagram, and small errors can result in erroneous decoding. To overcome this problem, a twin-class 64-QAM is proposed, with uniform and non-uniform signal space constellations, to give different degrees of error protection. Each constellation point, in 64-level QAM systems, is represented by a unique 6-bit symbol $i_1, q_1, i_2, q_2, i_3, q_3$. The position of the bits in the 6-bit QAM symbol has an effect on their error probabilities and they can create various sub-channels with different integrities [4]. In the 64-QAM constellation diagram, the two MSBs have lower error probabilities than the four LSBs. Consequently, the bits (i_1, q_1) and (i_2, q_2, i_3, q_3) can be viewed as two sub-channels each having different integrities; this will be referred as (2 - 4) splitting. To increase the capacity of the better protected sub-channel, it is possible to use a (3 - 3) partitioning where HP is formed by the three MSBs (i_1, q_1, i_2) and LP is formed by the three LSBs (q_2, i_3, q_3). To improve the transmission efficiency of the system, higher error protection can be applied to the most important units of the coded video data by using non-uniform 64-QAM. In the 2-4 splitting case, to improve the performance of the HP, the constellation of Figure 1 can be used with $\alpha > 1$, where alpha is the ratio of between

the minimum distance between quadrants (d_1) and minimum distance between points inside each quadrant (d_2) and is given as $\alpha = d_1/d_2$ [7].

In this case the performance of the HP will be improved at the expense of LP. Consequently, Fig 2 shows the Symbol Error Rate of the high and low priority sub-channels in 64-HQAM for different values of α . For the sake of comparison the performance of the non-partitioned 64-QAM (STD) is also presented. For a Gaussian channel, the performance of the HP is seen to have only a small advantage over the LP sub-channel. However, by increasing the degree of non-uniformity, ($d_1 > d_2$), the improvement of the HP performance is significant at the expense of the LP sub-channel.

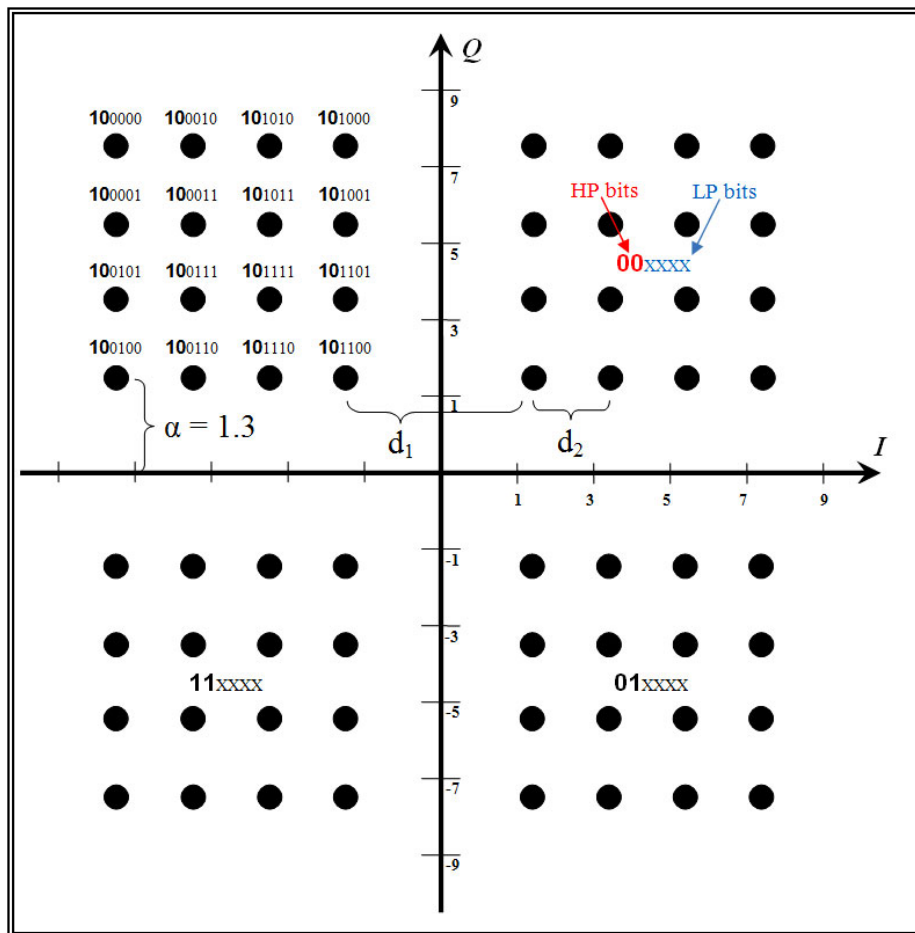

Fig. 1. 64-HQAM constellation diagram with $\alpha = 1.3$

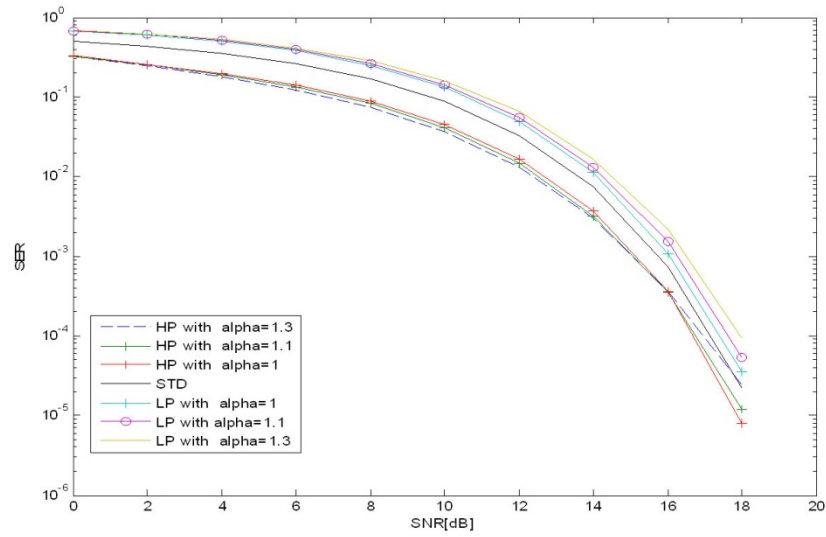

Fig. 2a. SER vs SNR for range of alpha for (3-3) splitting for 64 QAM

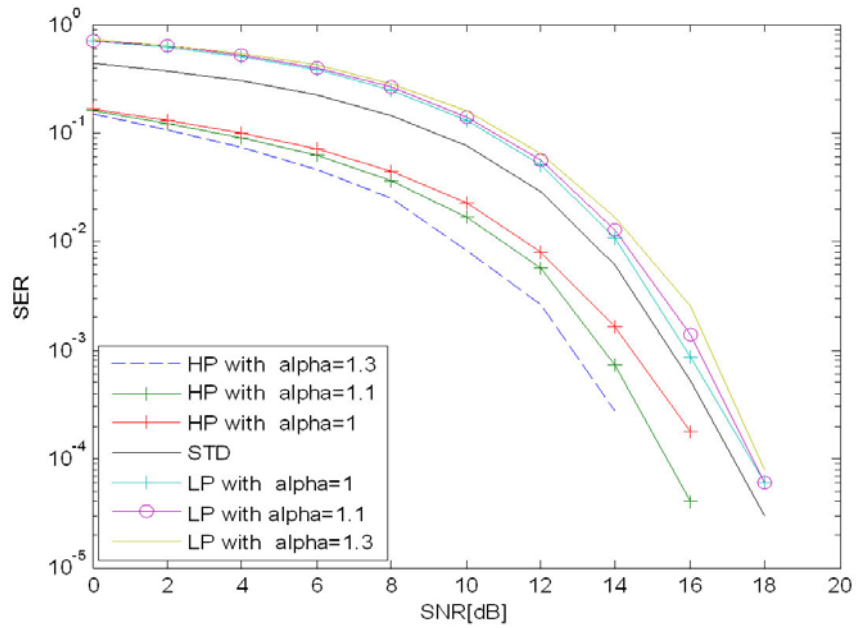

Fig. 2b. SER vs SNR for range of alpha for (2-4) splitting for 64 QAM

3 PROPOSED UEP USING 64-HQAM

The system block diagram of the proposed UEP scheme is shown in Fig 3. In this proposed scheme, the HP bits of the H.264/AVC coded video data are mapped to the MSB's of the modulation constellation points and the LP bits are mapped to LSB's of the hierarchical 64-QAM. Compared to the uniform error protection, in which the amount of protection allocated to the coded video sequence is uniformly distributed, in the proposed UEP the compressed video bit-stream is divided into two classes of priority, namely HP data and LP data. HP data contains the part of the compressed video bit-stream which is most sensitive to transmission errors; if errors affect the HP data the reconstructed video image quality will be severely degraded and therefore a higher amount of protection is allocated to protect this data. On the other hand, errors that effect on LP data will not cause significant distortions on the reconstructed video image and therefore a lower amount of protection can be applied. The two MSBs of the constellation points in hierarchical 64-QAM have lower BER than the two LSBs therefore they are used to transmit HP data while the two LSBs are used to transmit LP data.

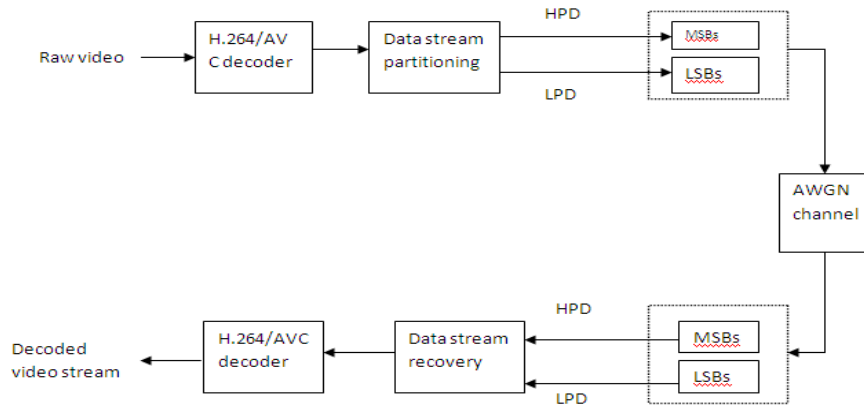

Fig. 3. Block diagram of the proposed UEP scheme

Fig 4 shows the group of pictures (GOP) of the video data. The first frame in a GOP, which is an-I frame, is classified as HP data, while the last six frames, which are P frames, are classified as LP data. The frames in the GOP have descending areas of important, so the first frame should have a higher protection. The transmission errors depend on the error position of the frame in the GOP, and when an error occurs in the beginning of a GOP the more frames are affected, while the errors in the last frames do not affect any other frames. The coded video data should be partitioned in a way that the first frame in a GOP is more protected than the last frame.

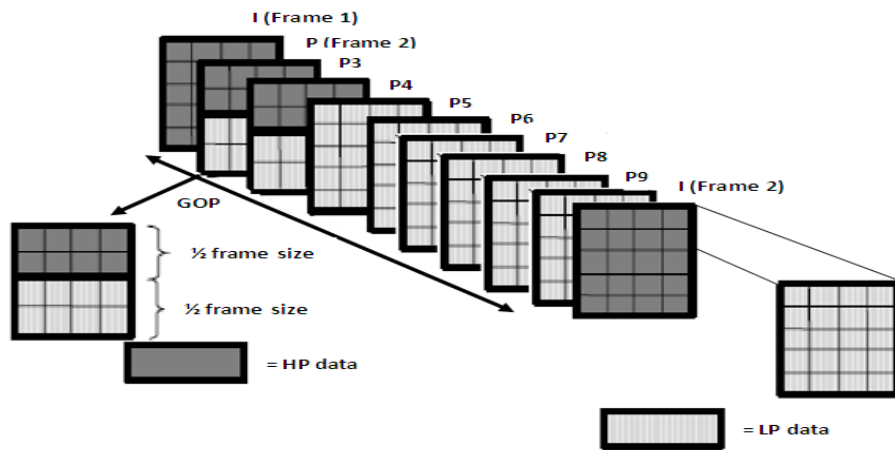

Fig. 4. Proposed UEP of the H.264/AVC

4 Simulation Results

For the purposes of this research work the H.264/AVC official reference software was used and the hierarchical 64-QAM and AWGN channel model were designed in MATLAB. The sequence known as “Suzie” was used, which conforms to the Quarter Common Intermediate Format (QCIF) of spatial resolution 176×144 pixels compressed to 42Kbit/s. The experiments were also concerned with the transmission aspects of the video data; uniform ($\alpha = 1$) and non-uniform ($\alpha = 1.1, 1.3$) partitioned 64-QAM was used to transmit the bit-stream via an AWGN channel. At the receiver end, the partitioned bit-stream was fed to the predecoder and the aligned bit-stream was forwarded to the H.264/AVC official reference software decoder.

In order to prohibit the temporal error propagation during transmission the I frame was inserted periodically every 9 frames. Results are based on fifty simulations performed with different AWGN seeds in order to obtain more reliable results.

The resulting PSNR for a 64-QAM system for both splitting cases for uniformly and non-uniformly partitioned bit-streams are presented in Figures 5, 6 and 7. By examining the uniform (3-3) and (2-4) splitting scenarios, it is easy to observe that the (2-4) scenario leads to a better quality of reconstructed video signal. The (3-3) scenario offers a slightly worst performance than the (2-4) case because the HP data of the (3-3) scenario suffers from high BER. Both these scenarios have better performance to the non-partitioned bit-stream STD. In contrast, when applying non-uniform partitioning with α equal 1.1 and 1.3, the performance of the system with (2-

4) splitting is seen to yield considerable improvement in the noisy situation as the channel SNR increases.

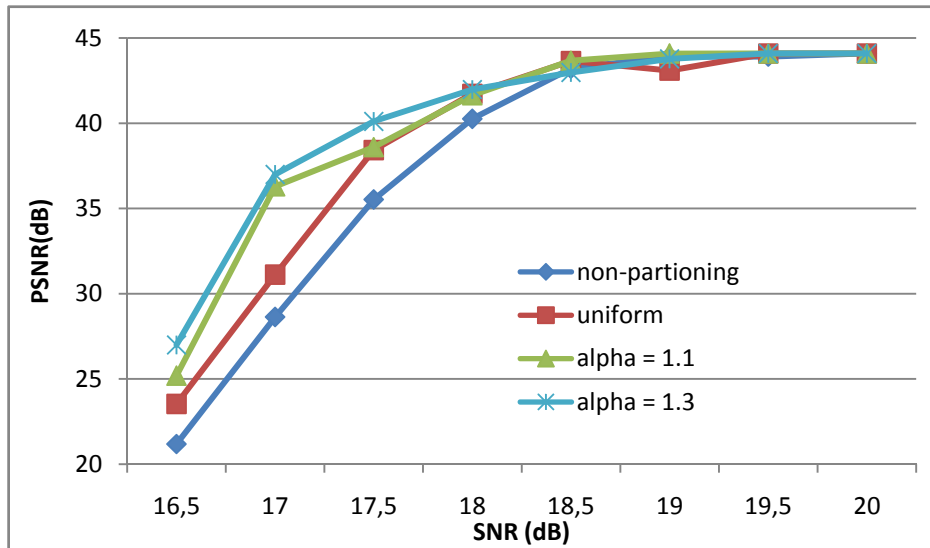

Fig. 5. PSNR vs. SNR , 3-3 splitting for 64-QAM

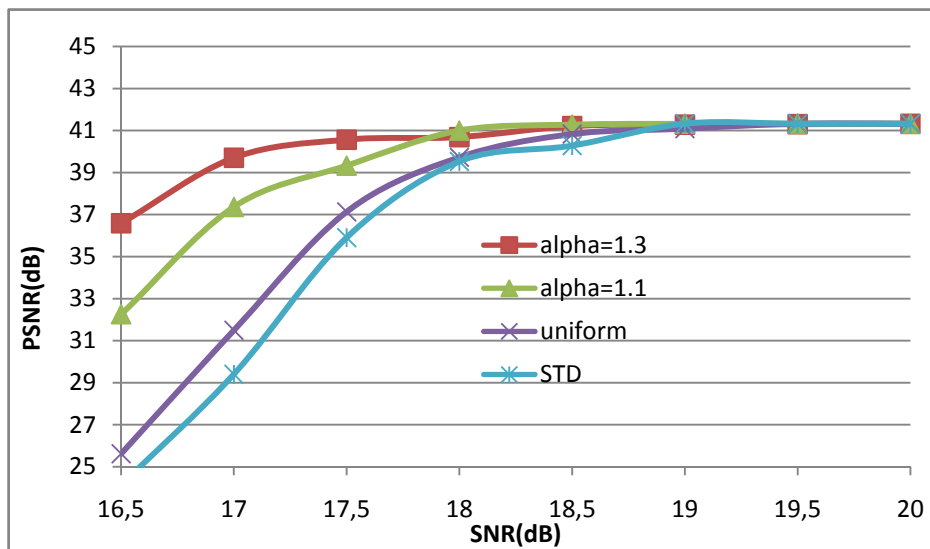

Fig. 6. PSNR vs. SNR, (2-4) splitting for 64-QAM

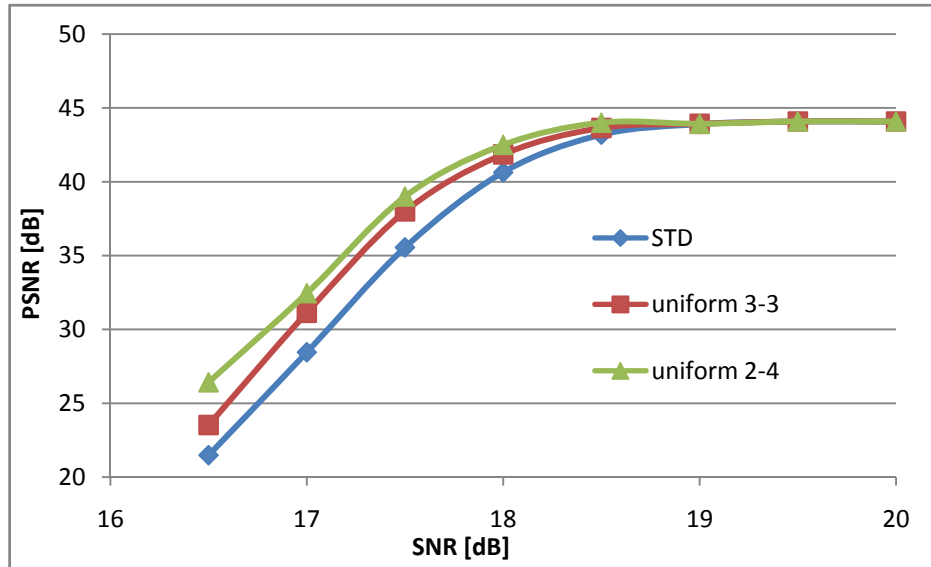

Fig. 7. PSNR performance comparison of 64-QAM

5 Conclusion

A hierarchical video coding scheme has been exploited in order to split the H.264 video data into an arbitrary number of partitions in decreasing order of visual importance. This was arranged by taking into consideration the visual importance as well as the sensitivity of the coded bit-stream against transmission errors. A twin class priority bit classification was established, in terms of the transmission aspects, to protect the vitally important video data bits (ability to reconstruct the main picture) by transmitting them via a High Priority channel, whereas the video enhancement bits (adding the detail) are transmitted over the Low Priority channel.

For the enhancement of multimedia applications, a 64-QAM system has been considered for transmitting the video data through a multi-priority channel utilizing a unique interface approach between the video data and the transmission elements. Various partitioning scenarios of the transmitted symbol and constellation arrangements have been investigated and the simulation results showed that the use of non-uniform constellations offer better video quality for error-prone channels. For the AWGN channel, for better channel conditions the uniform partitioned systems offer better performance. In particular, for small SNR values, best results are obtained by using a splitting that gives fewer bits to the high priority channel and separating the quadrants by the maximum possible distance.

It was observed that increasing the protection distances α and d_1 in the constellation diagrams the HP protection is increased but this decreases the LP protection. This method does not provide any error protection as does channel coding; what is actually offered is the unequal priority control to the different parts of the data. In order to further enhance the performance of the transmission system in wireless channels, the use of more sophisticated error correcting codes is expected to offer a big improvement in the performance of a mobile video communication system.

6 References

1. Theodorakopoulos, V., Woodward, M.E., Sotiropoulou, K.: A dual priority M-QAM transmission system for high quality video over mobile channels. In: 1st IEEE International Conference on Distributed Frameworks for Multimedia Applications, pp. 218--225. IEEE Press, Besancon (2005)
2. Gharavi, H.: Pilot- assisted 16-level QAM for wireless video. In: IEEE Transactions on Circuits and Systems for Video Technology, vol. 12, No 2, pp. 77--89 (2002)
3. Theodorakopoulos, V., Woodward, M.E.: Comparative analysis of a twin-class M-QAM transmission system for wireless video applications. Journal of Multimedia Tools and Applications, Special Issue: Wireless Multimedia, Vol. 28, Issue 1, pp. 125--139 (2006)
4. Stedman, R., Gharavi, H., Hanzo, L., Steel, R.: Transmission of subband coded images via mobile channels. In: IEEE Transactions on Circuits and Systems for Video Technology, vol. 3, No 1, pp. 15--26 (1993)
5. Wei, L.-F.: Coded modulation with unequal error protection. In: IEEE Transactions on Communications, vol. 41, No 10, pp. 1439--1449 (1993)
6. O'Leary, S.: Hierarchical transmission and COFDM systems. In: IEEE Transactions on Broadcasting, vol. 33, pp. 166--174 (1997)
7. Chang, Y.C., Lee, S.W., Komiya, R.: A Low-Complexity Unequal Error Protection of H.264/AVC Video Using Adaptive Hierarchical QAM. In: IEEE Transactions on Consumer Electronics, vol. 52, No 4, pp. 1153--1158 (2006)
8. Abdurrahman, A.B., Woodward, M.E.: Unequal Error Protection For Data Transmission Using Adaptive Hierarchical QAM. In: 9th Annual Postgraduate Symposium on The Convergence of Telecommunications, Networking and Broadcasting, pp. 1153--1158 (2008)